

EN

Pure shower screen
INSTRUCTION MANUAL

DE

Pure Dusche
BEDIENUNGSANLEITUNG

FR

Pure douche
MODE D'EMPLOI

HU

Pure zuhanykabin
HASZNÁLATI UTASÍTÁS

SORRENTO

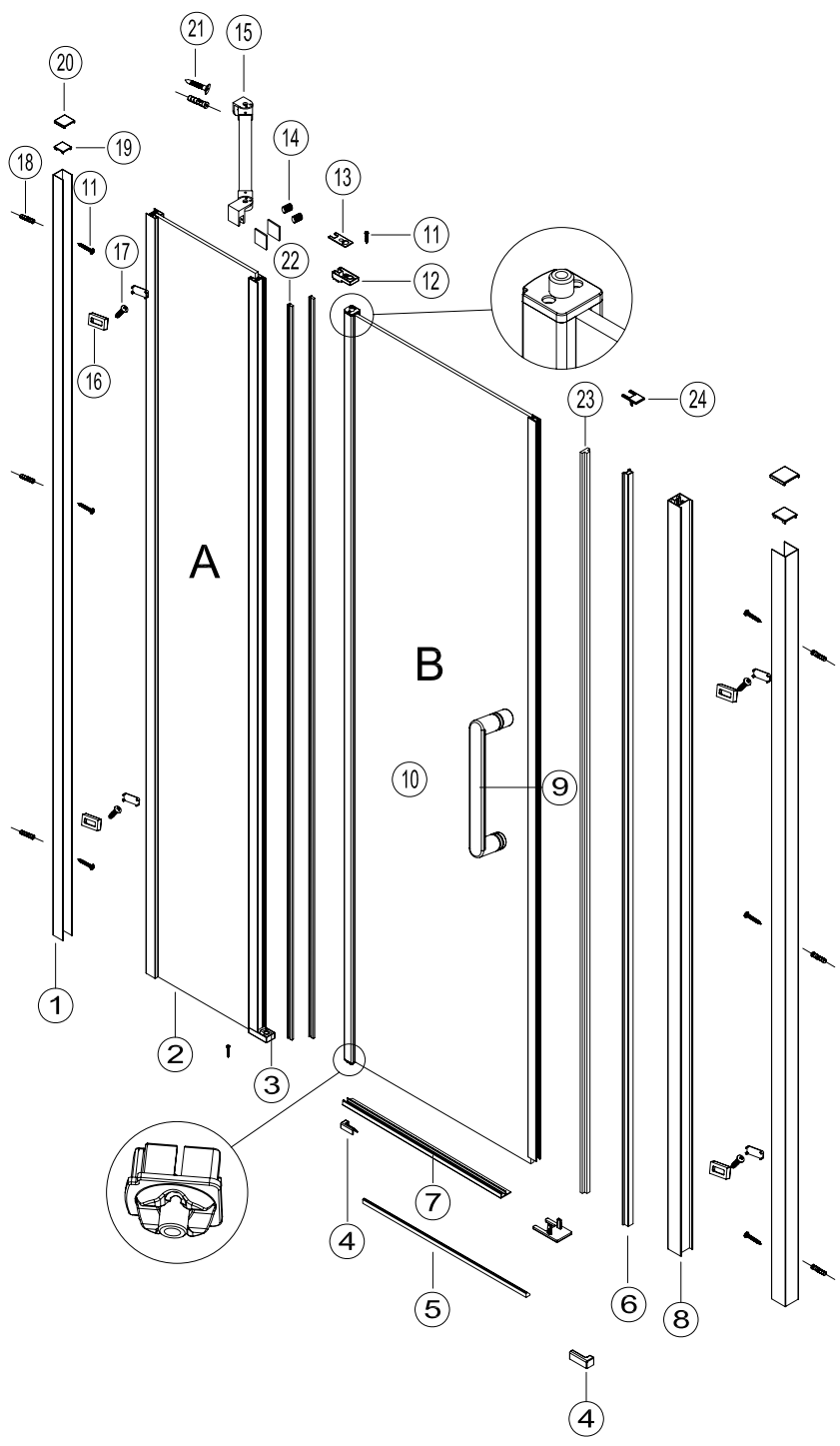

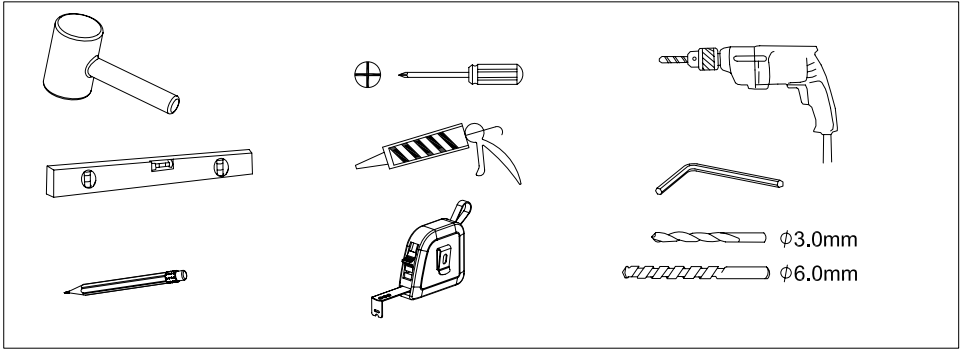

| | | | | | | | |
|---|--|----------|-----|---|--|----------|-----|
| ① | | AL052 | X 2 | ⑮ | | PL041 | X 7 |
| ② | | A | X 1 | ⑰ | | PL065 | X 2 |
| ③ | | HD030 | X 1 | ⑳ | | PL066 | X 2 |
| ④ | | PL075L/R | X 2 | ㉑ | | ST4X30 | X 1 |
| ⑤ | | AL016 | X 1 | ㉒ | | JT015 | X 2 |
| ⑥ | | JT003-05 | X 1 | ㉓ | | JT003-06 | X 1 |
| ⑦ | | JT005-01 | X 1 | ㉔ | | PL099 | X 2 |
| ⑧ | | AL054 | X 1 | | | | |
| ⑨ | | HD053 | X 1 | | | | |
| ⑩ | | B | X 1 | | | | |
| ⑪ | | ST4X30 | X 8 | | | | |
| ⑫ | | HD031 | X 1 | | | | |
| ⑬ | | PL062 | X 1 | | | | |
| ⑭ | | M5x5 | X 2 | | | | |
| ⑮ | | HD034 | X 1 | | | | |
| ⑯ | | PL063 | X 4 | | | | |
| ⑰ | | ST4X8 | X 4 | | | | |



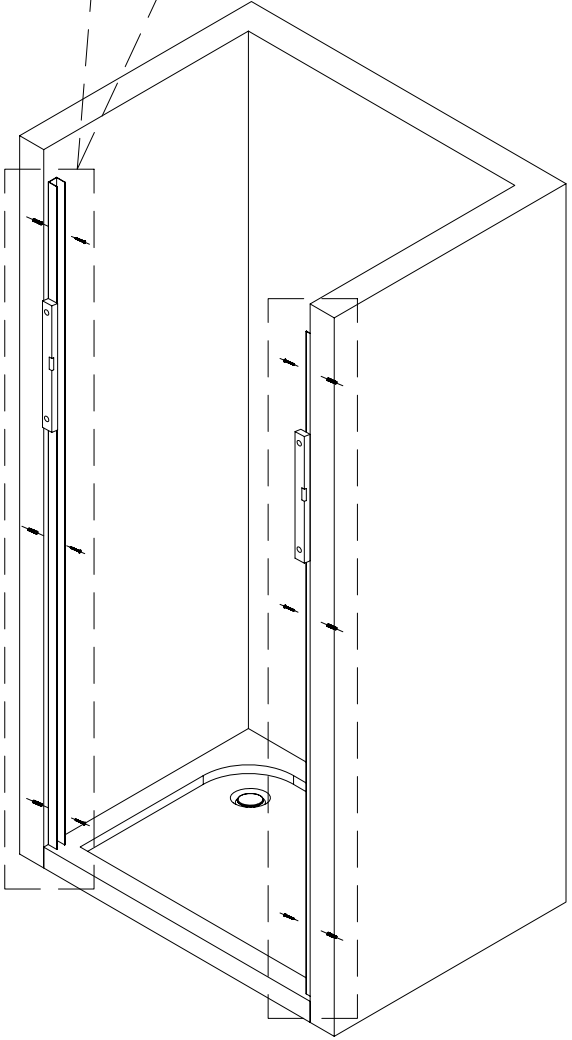
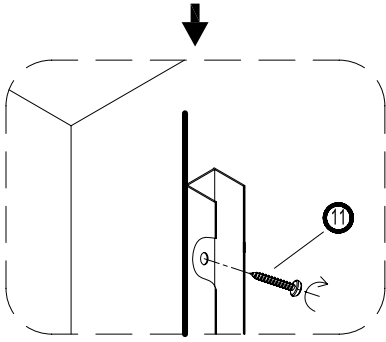
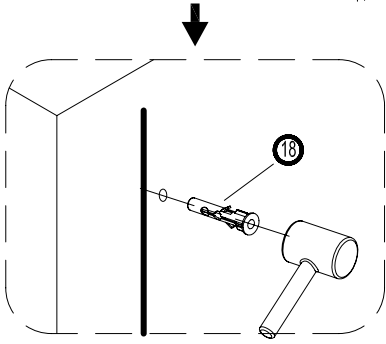
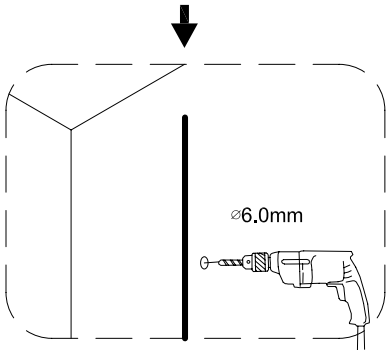
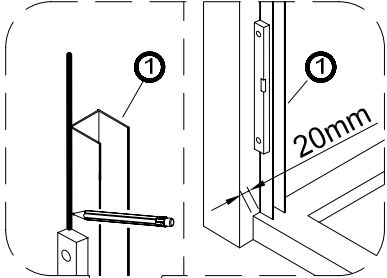
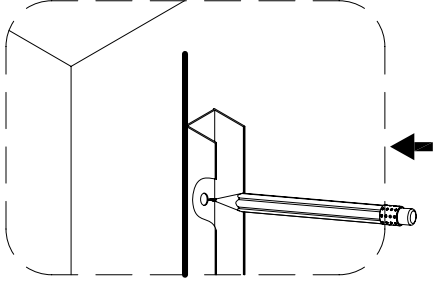
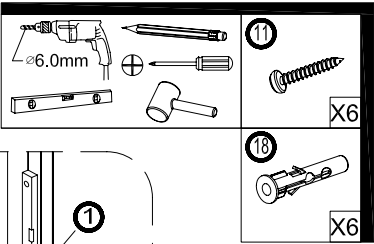

1

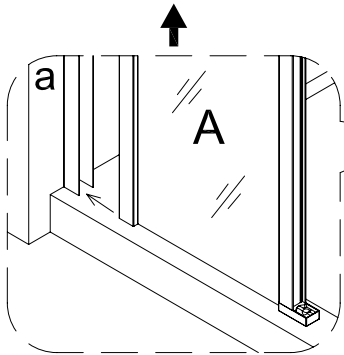
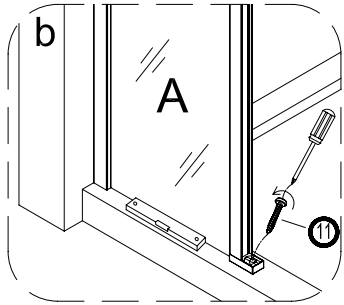
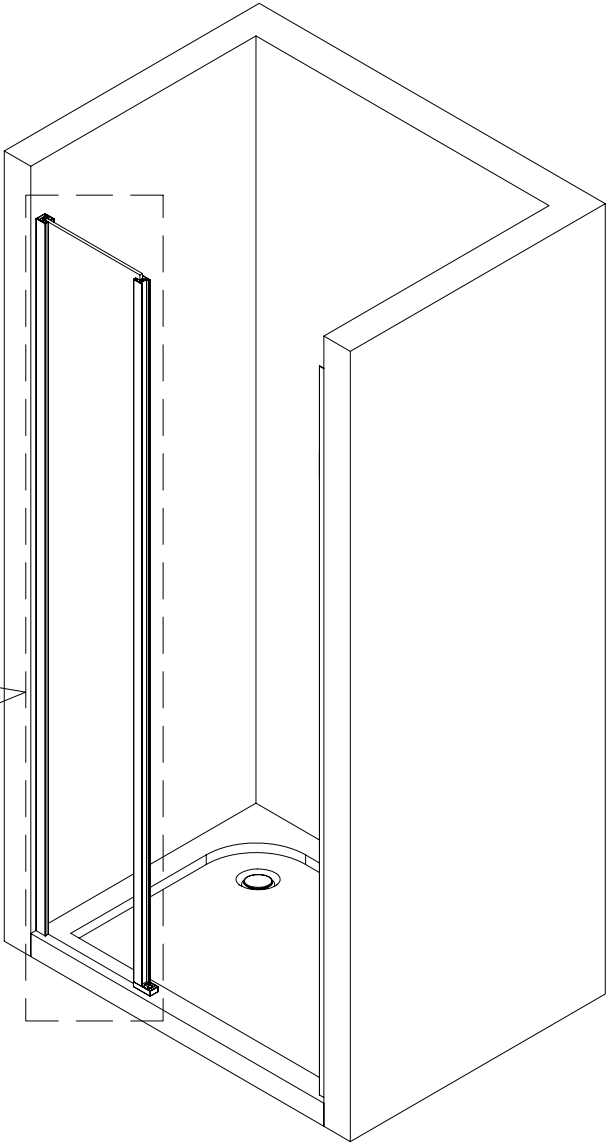
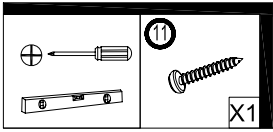

2

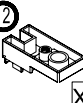

3

- ⊕ 
- 11  X1
- 24  X2
- 12  X1
- 13  X1

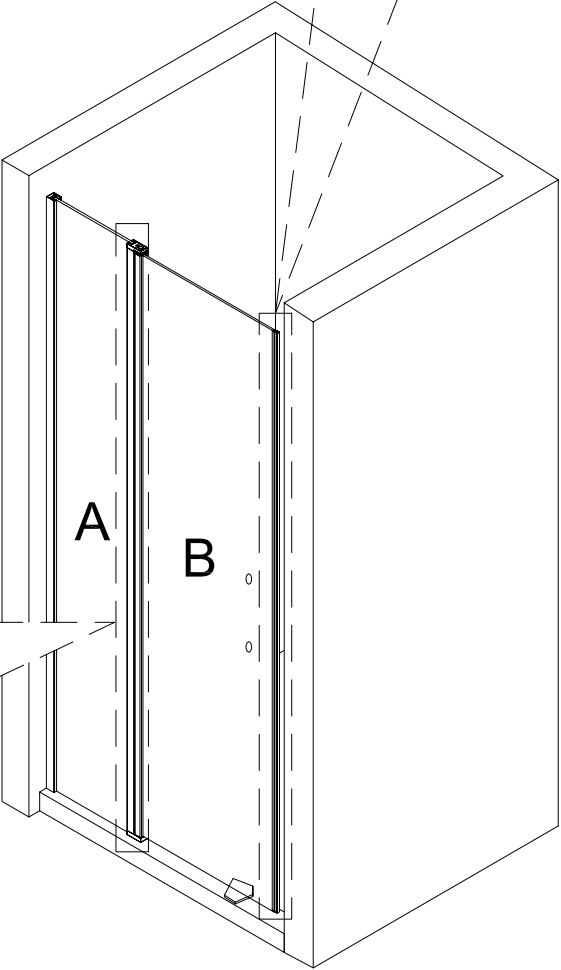
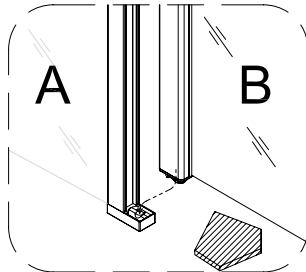
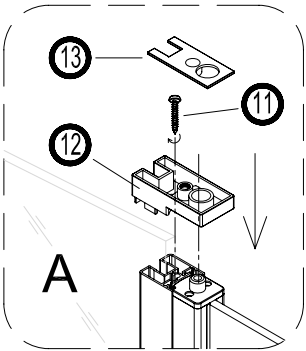
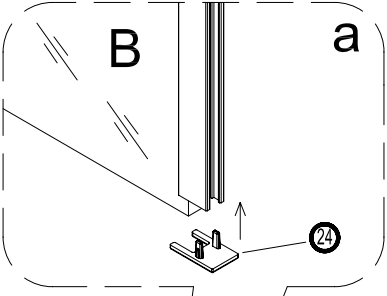
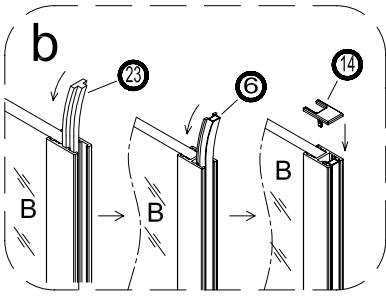

4

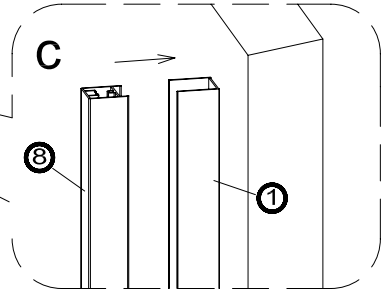
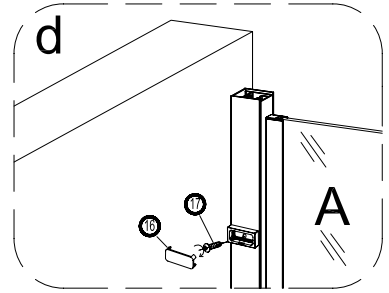
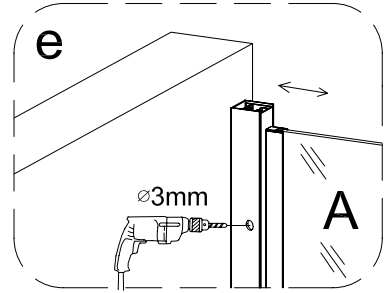
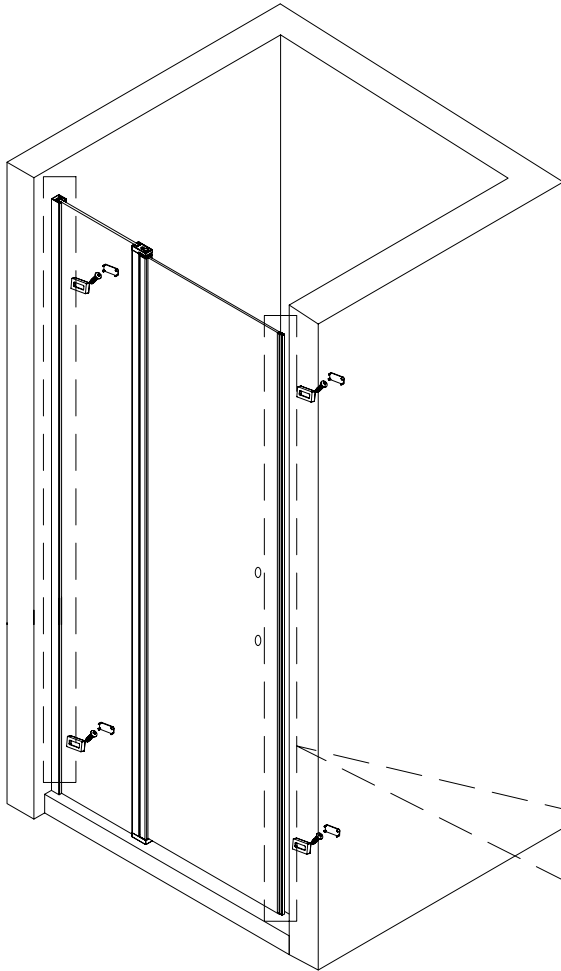
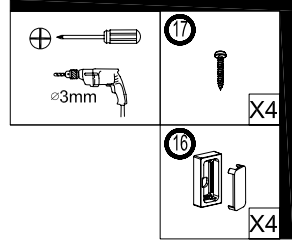

5

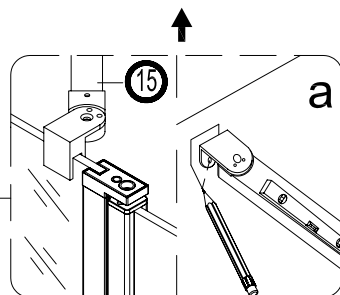
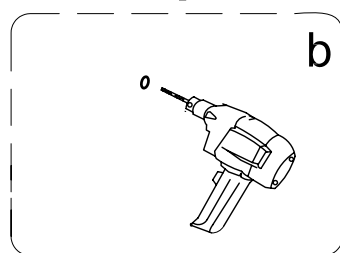
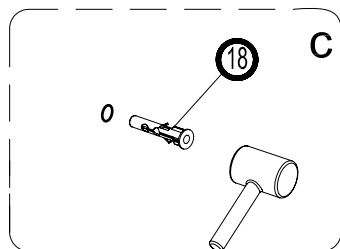
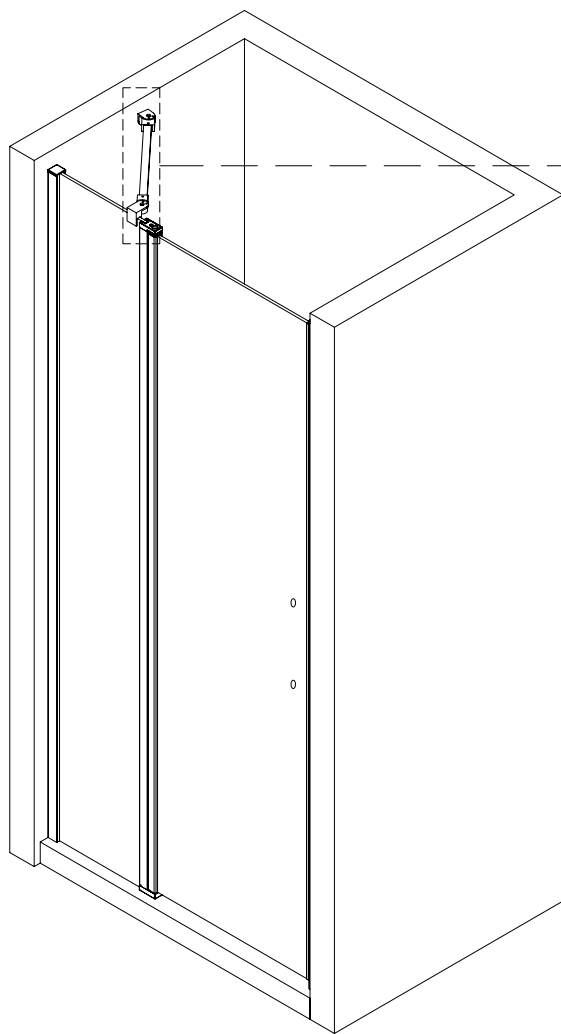
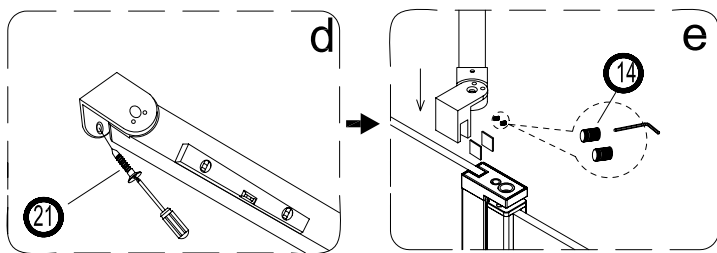

6

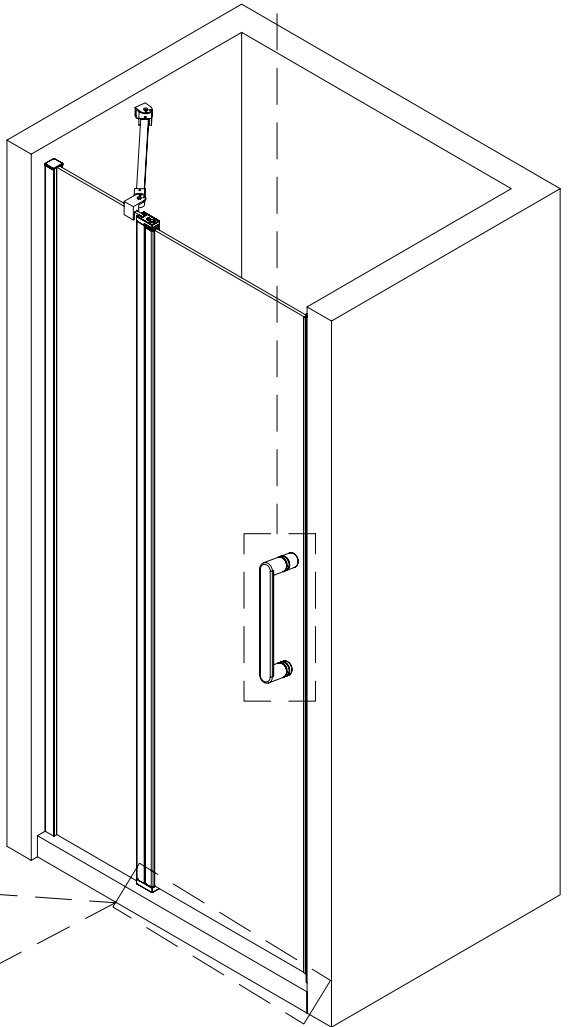
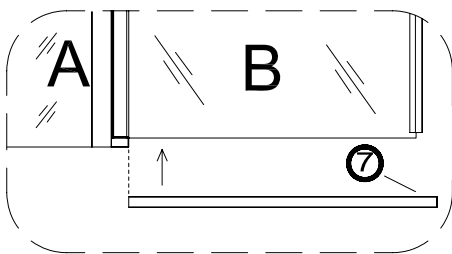
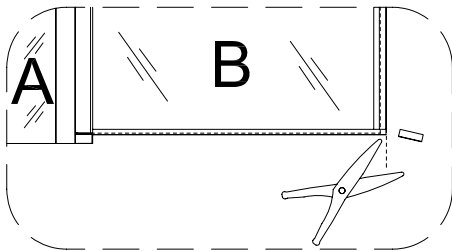
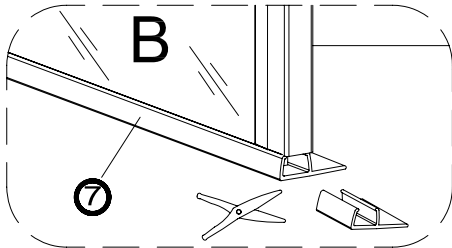
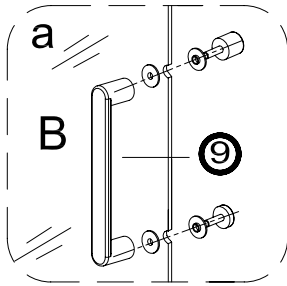
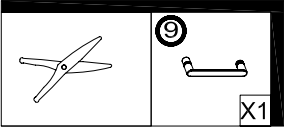

7

