

EN

**Sorrento plus shower cabin**  
INSTRUCTION GUIDE

DE

**Sorrento plus dusch kabine**  
AUFBAU ANLEITUNG

FR

**Cabine de douche Sorrento plus**  
GUIDE D'INSTALLATION

HU

**Sorrento plus zuhanykabin**  
SZERELÉSI ÚTMUTATÓ

RO

**Cabină de duș Sorrento plus**  
INSTRUCȚIUNI DE MONTARE

WC00506  
WC00505  
WC00504  
WC00503  
WC00502  
WC00501  
WC00500  
WC00499

**Sorrento plus 90/100/120/140**

## General Information

Please inspect the product immediately upon receipt for transit damage, missing packs/parts or manufacturing fault. Damage reported later cannot be accepted. Please handle the product with care avoiding knocks and shock loading to all sides and edges of the glass.

**Note: Safety glass can not be re-worked.**

## Installation

Please read these instructions carefully before start of installation.

The wall post has up to 20 mm of adjustment for put of true wall situations.

Ensure that the shower tray is fitted level and that after assembly of enclosure there is a and continuous bead of sealant between the top of the shower tray and the tile joint.

Special care should be taken when drilling walls to avoid hidden pipes or electrical cables.

**Note: This product is heavy and will require two people to install.**

Please remove protective film from aluminium profiles before installation.

## Shower Tray Installation

The shower tray must be sited against a structural wall.

Water proof walling or tiling should be fitted so that it sits on the top of the tray rim.

## Aftercare Instructions

After use, your shower should be cleaned with soap and water. This is particularly important in hard water districts where insoluble lime salts may be deposited and allowed to build up. Cleaners of a gritty or abrasive nature should not be used. Care should be taken to avoid contact with strong chemicals such as organic solvents and strippers.

Glass cleaners can be used but with caution, if in doubt contact the supplier of the cleaner in question.

Please keep these instructions for aftercare and customer service details.

## Tools Required

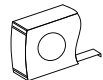
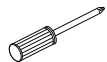
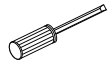
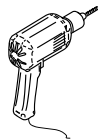
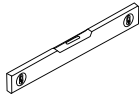
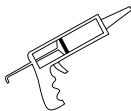

**This product is heavy and may require two people to install.**



## Allgemeine Information

Bitte überprüfen Sie das Produkt sofort nach Erhalt nach Transportschäden, fehlenden Packungen/ Teilen oder Herstellerfehlern. Schäden, die später gemeldet werden können nicht akzeptiert werden. Bitte behandeln Sie dieses Produkt mit Vorsicht, vermeiden Sie Stöße und Erschütterungen an allen Seiten und den Kanten des Glas.

**Achtung: Sicherheitsglas kann nicht erneut bearbeitet werden.**

## Installation:

Bitte lesen Sie diese Anleitung sorgfältig, ehe Sie mit dem Aufbau beginnen. Die Stützwand bietet bis zu 20mm Anpassung für komplizierte Wandsituationen.

Vergewissern Sie sich, dass die Duschwanne eben ist und es nach der Montage des Gehäuses eine vollständige und kontinuierliche Silikon Dichtstoffschicht gibt, zwischen der Spitze der Duschwanne und dem Fliesengelenk.

Besondere Sorgfalt sollte gewährt sein wenn Wände angebohrt werden, um versteckte Leitungen oder elektrische Kabel zu vermeiden.

**Achtung: Dieses Produkt ist schwer und es werden zwei Personen zum Aufbau benötigt.**

Bitte entfernen Sie den Überzug vor dem Aufbau.

## Duschwanne Aufbau

Die Duschwanne muss gegen eine strukturelle Wand gelehnt sein. Wasserdichte Wände oder Fliesen sollten so angebracht sein, dass sie auf der Oberseite des Wannenrandes sitzen.

## Anleitung zur Pflege

Nach der Benutzung sollte die Dusche mit Wasser und Seife gesäubert werden. Das ist besonders wichtig, bei Bezirken mit hartem Wasser, wo unlösliche Kalksalze sich festsetzen und sich ansammeln können. Reiniger die kiesig und scheuernd sind, sollten nicht benutzt werden. Der Kontakt mit starken Chemikalien wie organische Lösungsmittel und Beize sollte vermieden werden, Glasreiniger können mit Vorsicht benutzt werden, bei Frage kontaktieren Sie den Lieferer oder den infrage kommenden Reiniger.

Bitte bewahren Sie diese Anleitung zur Nachpflege und Kundenservicedetails auf.

## Benötigte Werkzeuge

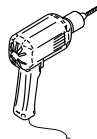
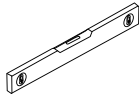
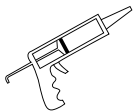

Ø 6mm

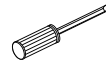

Ø 3.2mm

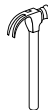
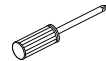

**Das Produkt ist schwer und benötigt zwei Menschen beim Aufbau!**



## Informations générales

Veuillez inspecter cela immédiatement après réception pour les dommages de transport, l'absence de paquets/pièces ou les défauts de fabrication. Les dommages signalés plus tard ne peuvent pas être acceptés. Veuillez manipuler le produit avec précaution en évitant les chocs et la charge de choc pour tous les côtés et les bords de la vitre.

Remarque : le vitre de sécurité ne peut pas être re-construit.

## Installation

Veuillez lire attentivement ces instructions avant de commencer l'installation.

Le pieu du mur a jusqu'à 20 mm d'ajustement pour des situations d'un mur réel.

Assurez-vous que le bac de douche est bien monté et qu'après le montage du boîtier il y a un cordon d'étanchéité plein et continu entre la partie supérieure du bac de douche et le joint carré

Des précautions particulières doivent être prises lors du perçage des murs pour éviter les tuyaux cachés ou les câbles électriques. Remarque: Ce produit est lourd et nécessitera deux personnes pour l'installer. Veuillez retirer le film protecteur des profils d'aluminium avant l'installation.

## Installation du bac de douche

Le bac de douche doit être placé contre un mur structurel. Les murs étanches ou avec carrelage doivent être montés de sorte qu'il se pose sur le haut du bord du bac.

## Instruction de suivi

After use, your shower should be cleaned with soap and water. This is particularly important in hard. Après utilisation, votre douche doit être nettoyée avec de l'eau et du savon. Cela est particulièrement important dans les quartiers à eau calcaire où les sels de chaux insolubles peuvent être déposés et permis de s'accumuler. Les nettoyeurs abrasifs ou graveleux ne doivent pas être utilisés. Des précautions doivent être prises pour éviter tout contact avec des produits chimiques tels que les solvants organiques et les racleurs. Les nettoyeurs de verre peuvent être utilisés mais avec prudence, en cas de doute, contactez le fournisseur en question. Veuillez conserver ces instructions pour les détails du suivi et du service clients.

## Outils requis

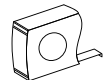
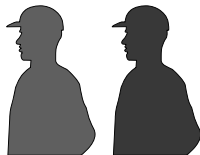
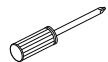
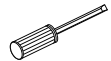
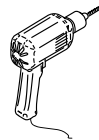
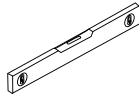
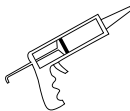

Ce produit est lourd et nécessite deux personnes pour l'installer



## Általános információ

Kérjük, azonnal vizsgálja meg a terméket szállítás után az esetleges sérülések, hiányzó csomagolások /alkatrészek miatt! A károk későbbi jelentése nem fogadható el. Óvatosan bánjon a termékkel elkerülve az üveg oldalain és élein jelentkező ütődéseket és rázkódásokat!

Megjegyzés: A biztonsági üveg nem utólag nem alakítható!

## Szerelés

Kérjük, figyelmesen olvassa el ezt az útmutatót, mielőtt hozzátárna a szereléshez! A fali fogantyúnak 20 mm-ig terjedő, a fal adott helyzetéhez igazodó állítási lehetőséget kell biztosítani!

Győződjön meg arról, hogy a zuhanytálca szintre lett állítva és a zuhanyajtó összeszerelése után teljes és folytonos a tömítés a zuhanytálca és a csatlakozólap között!

Különös figyelmet kell szentelni lyukak falba való furásánál arra, hogy elkerülje a falba rejtett csöveket és elektromos vezetékeket!

Megjegyzés: Ez egy nehéz termék és felszerelése két személyt igényel! Kérjük szerelés előtt távolítsa el az alumínium elemekről a védőfóliát!

## Zuhanytálca szerelése

A zuhanytálcának az épület egyik falához kell támaszkodnia!

Vízhatlan csempét vagy lapot úgy kell beilleszteni, hogy a tálca felső pereméhez illeszkedjen!

## Karbantartási útmutatások

Használat után a zuhanyzót szappannal és vízzel meg kell tisztítani! Ez különösen fontos olyan körzetekben, ahol a víz kemény és meszes környezetben oldhatatlan sók rakódhatnak le és sörétegek épülhetnek fel. Ne használjon szemcsés szerkezetű vagy csiszoló jellegű tisztítószer-t! Ügyeljen arra, hogy elkerülje erős vegyszerekkel, mint szerves oldószerekkel és higító való érintkezést!

Ablaktisztító óvatosan használható, és kétely vagy kérdés esetén lépjen kapcsolatba a tisztítószer forgalmazójával!

Kérjük, kövesse ezeket a karbantartási és ügyfélszolgálati útmutatásokat!

## Szükséges eszközök

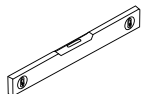
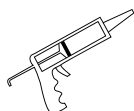

Ø 6mm

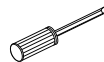

Ø 3.2mm

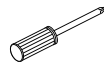

**Ez egy nehéz termék és szerelése két személyt igényel!**



## Informații generale

Vă rugăm să verificați produsul imediat după livrare pentru eventuale deteriorări, ambalaje/piese lipsă! Reclamații ulterioare nu se primesc. Manipulați produsele cu grijă, evitând lovirea marginilor!  
Notă: Sticla securizată nu este formabilă!

## Instalarea

Citiți cu atenție instrucțiunile înainte de a începe montarea! Mânerul de perete trebuie să dispună de un spațiu de reglare de până la 20 mm!

Cada de duș trebuie montată la nivel, iar după montarea ușii etanșarea este continuă și completă între cadă și placa de legătură!

Acordați atenție deosebită la realizarea găurilor în pereți, pentru a evita țevile și cablurile electrice încastrate în perete!

Notă: Acesta este un produs greu, montarea necesită două persoane! Îndepărtați folia de protecție de pe elementele de aluminiu!

## Montarea căzii de duș

Cada de duș trebuie să se sprijine de un perete al construcției!

Gresia sau faianța rezistentă la apă se montează lipită de marginea superioară a căzii!

## Instrucțiuni de întreținere

Spălați dușul cu apă și săpun după utilizare! Acest lucru este deosebit de important în mediile cu apă dură și calcaroasă, în care se depun săruri și se pot acumula straturi de săruri. Nu folosiți agent de curățare granulat sau abraziv! Evitați contactul cu agenți de curățare puternici sau solvenți organici și diluanți!

Soluția pentru spălat geamurile se folosește cu precauție, dacă aveți întrebări, luați legătura cu vânzătorul soluției de curățare!





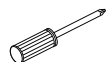
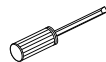
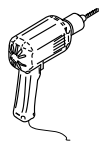
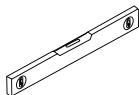
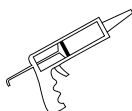









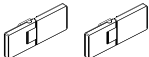

Respectați aceste instrucțiuni de întreținere și de relații cu clienții!

## Scule necesare



**Acesta este un produs greu, montarea necesită două persoane!**



	
[1] [2]	
[3] [4]	
[5] [6]	
[7] [8] [9]	
[10]	
[11] [12]	
[13]	
[14]	
[15]	
[16] [17]	
[18]	
[19]	
[20]	
[21]	
[22]	
[23] [24]	

Assembly Drawing / Montagezeichnung  
Dessin d'assemblage / Szerelési rajz / Desen de asamblare

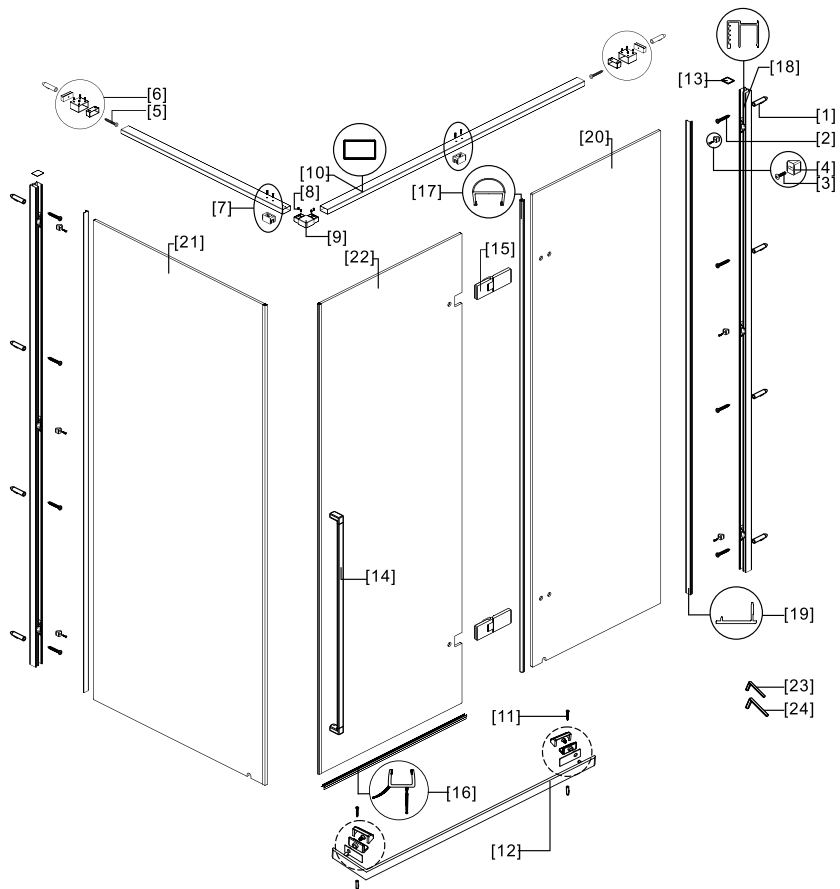



# Installation Steps / Installationschritte

## Etapes d'installation / Telepítési lépések / Pași de instalare

1

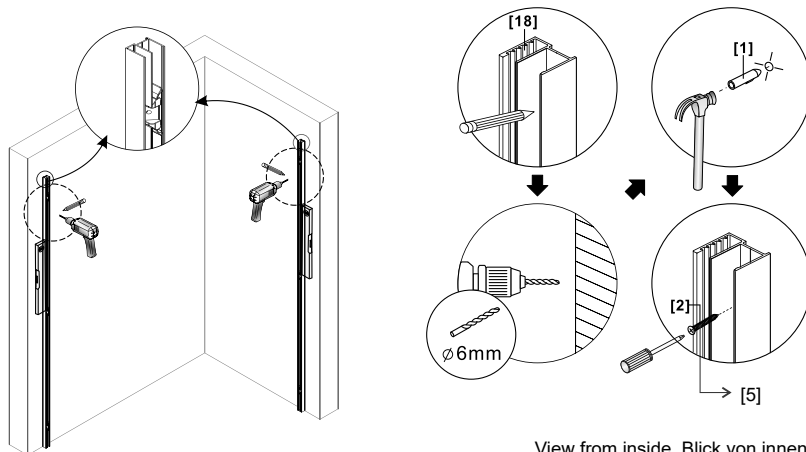

View from inside, Blick von innen  
 Vue de l'intérieur, Belső nézet, Vedere din interior

2

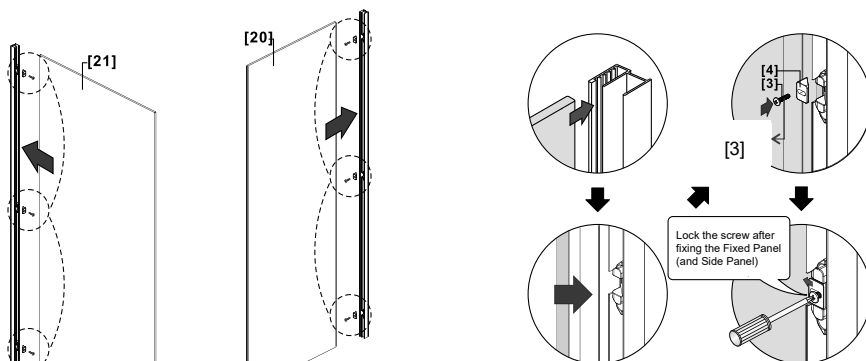

**DE** Verriegeln Sie die Schraube nach dem Befestigen der festen Verkleidung (und der Seitenverkleidung). **FR** Verrouillez la vis après avoir fixé le panneau fixe (et le panneau latéral) **HU** A rögzített panel (és az oldalsó panel) rögzítése után rögzítse a csavart **RO** Blocați șurubul după fixarea panoului fix (și a panoului lateral)

View from inside, Blick von innen  
 Vue de l'intérieur, Belső nézet, Vedere din interior

3

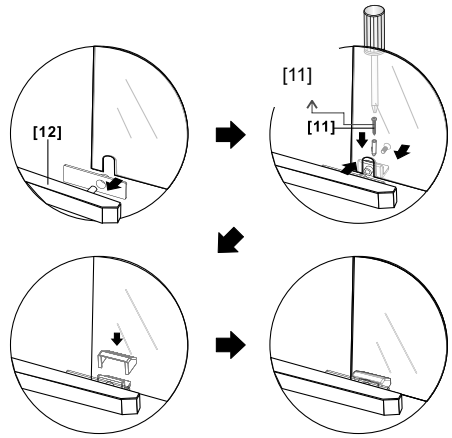
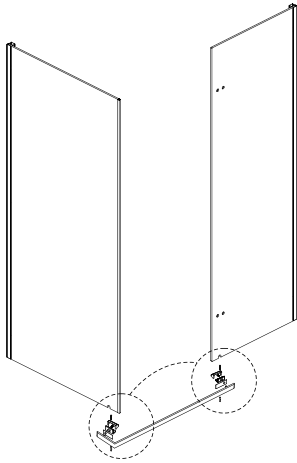

4

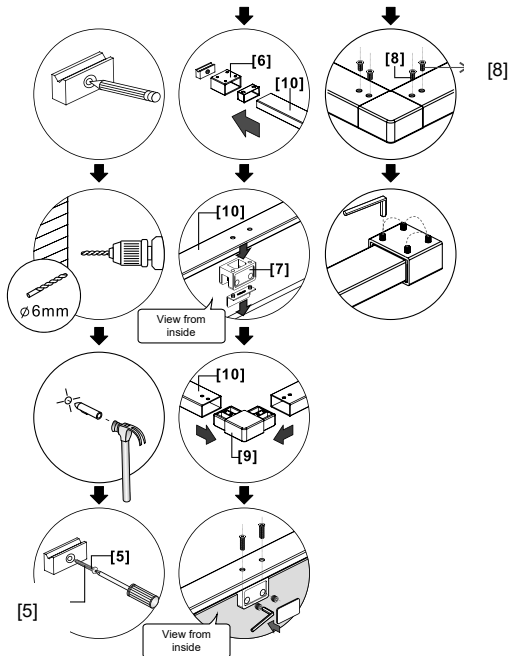
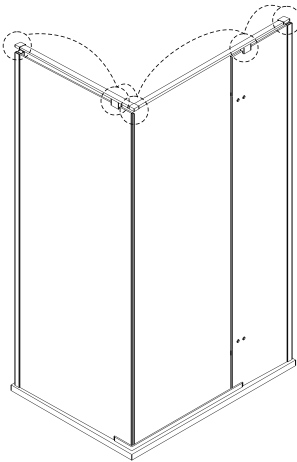

View from inside, Blick von innen  
 Vue de l'intérieur, Belső nézet, Vedere din interior

5

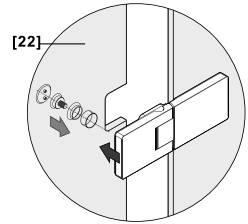
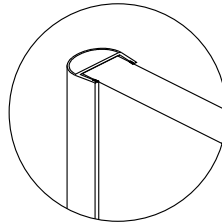
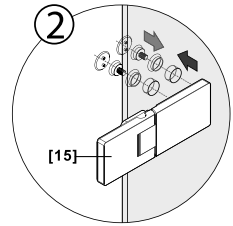
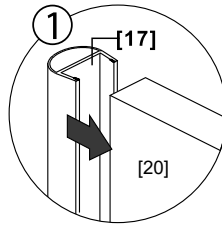
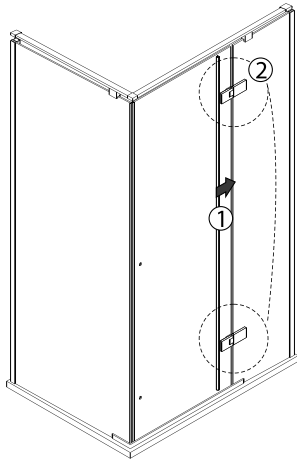

6

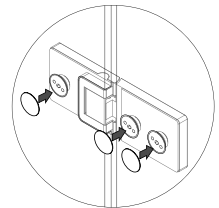
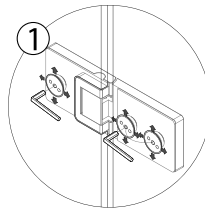
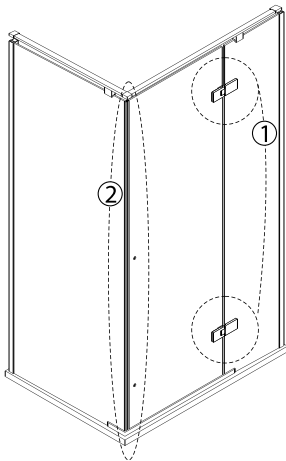

View from inside, Blick von innen  
 Vue de l'intérieur, Belső nézet, Vedere din interior

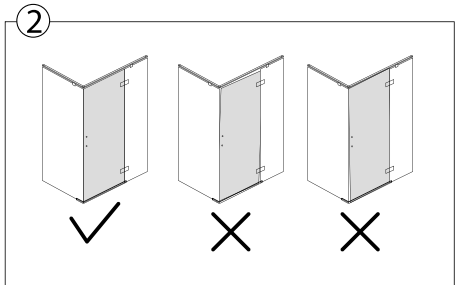

7

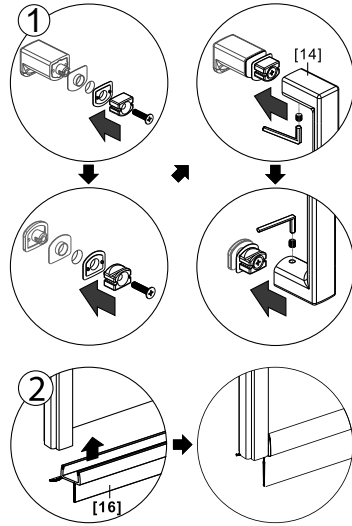
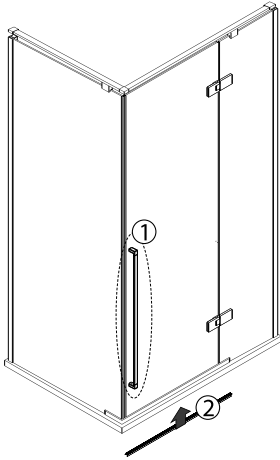

8

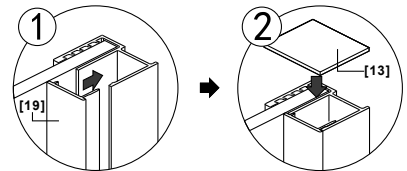
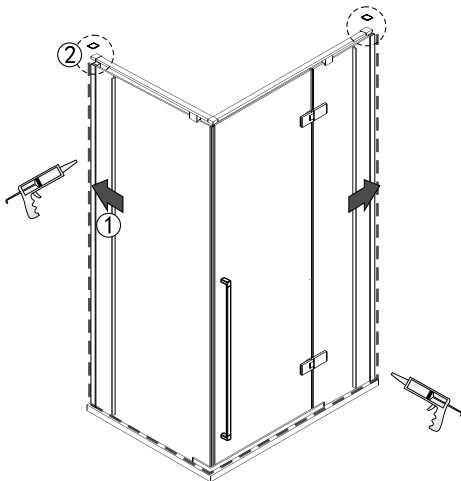

View from inside, Blick von innen  
Vue de l'intérieur, Belső nézet, Vedere din interior



