











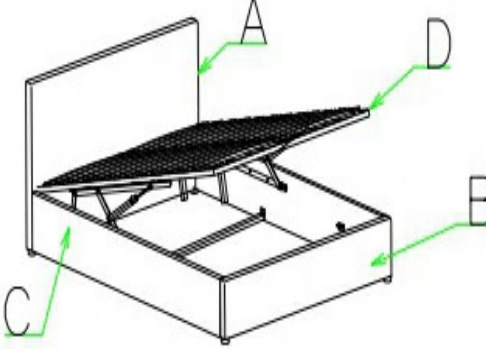
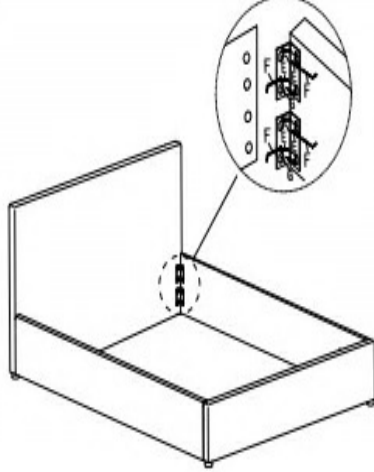
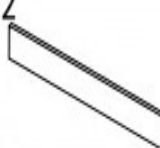
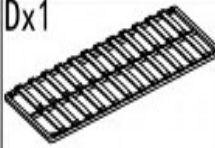



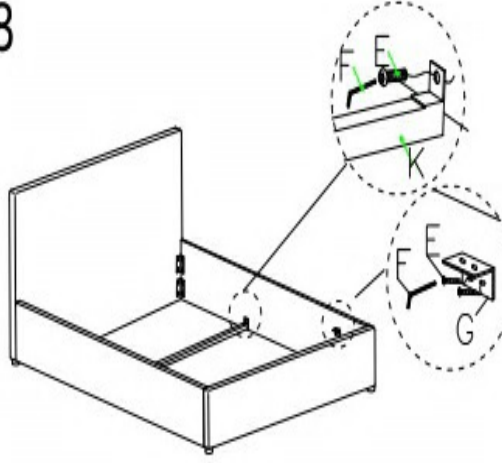
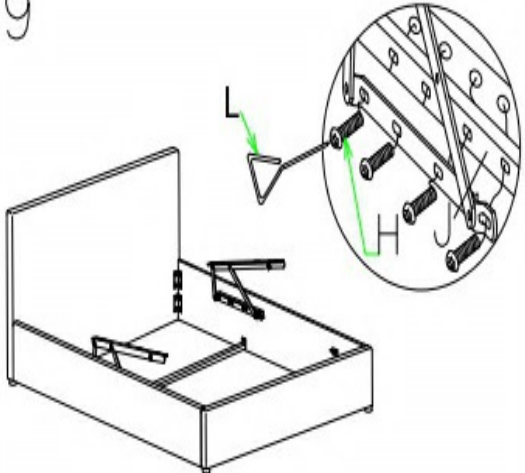

Ax1 	Bx1 	6 	7 
Cx2 	Dx1 		
Ex30  (8*20)	Fx1 		
Gx8 	Hx8  (8*40)	8 	9 
Ix1 	Jx2 		
Kx1 	Lx1 		
Mx4 	Nx2 	10 	
Ox2 	Px4  (8*50)		
Qx2 	Rx1 		

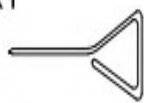
11

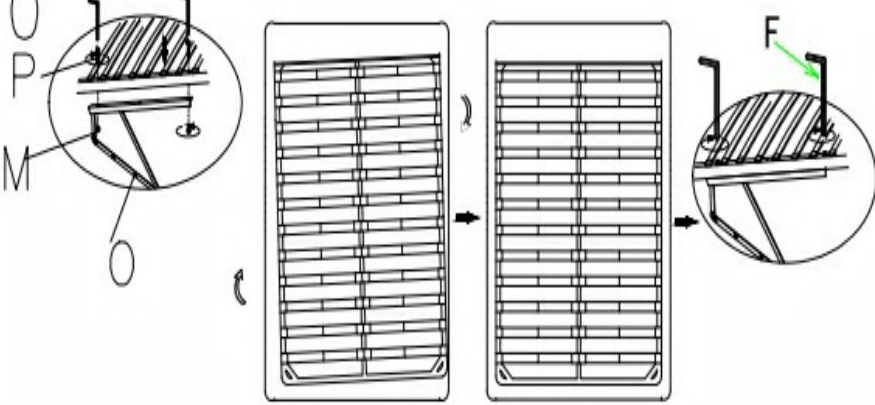

12

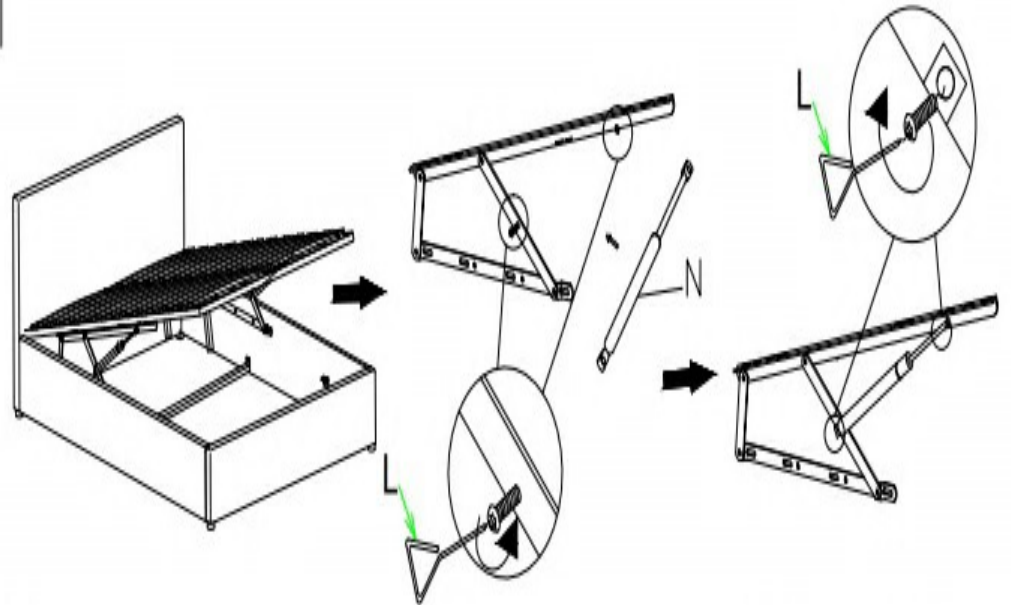
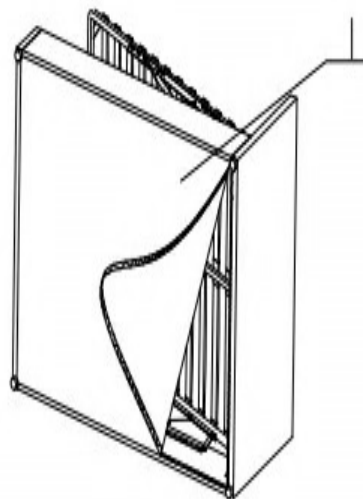

13

