

Typ Q

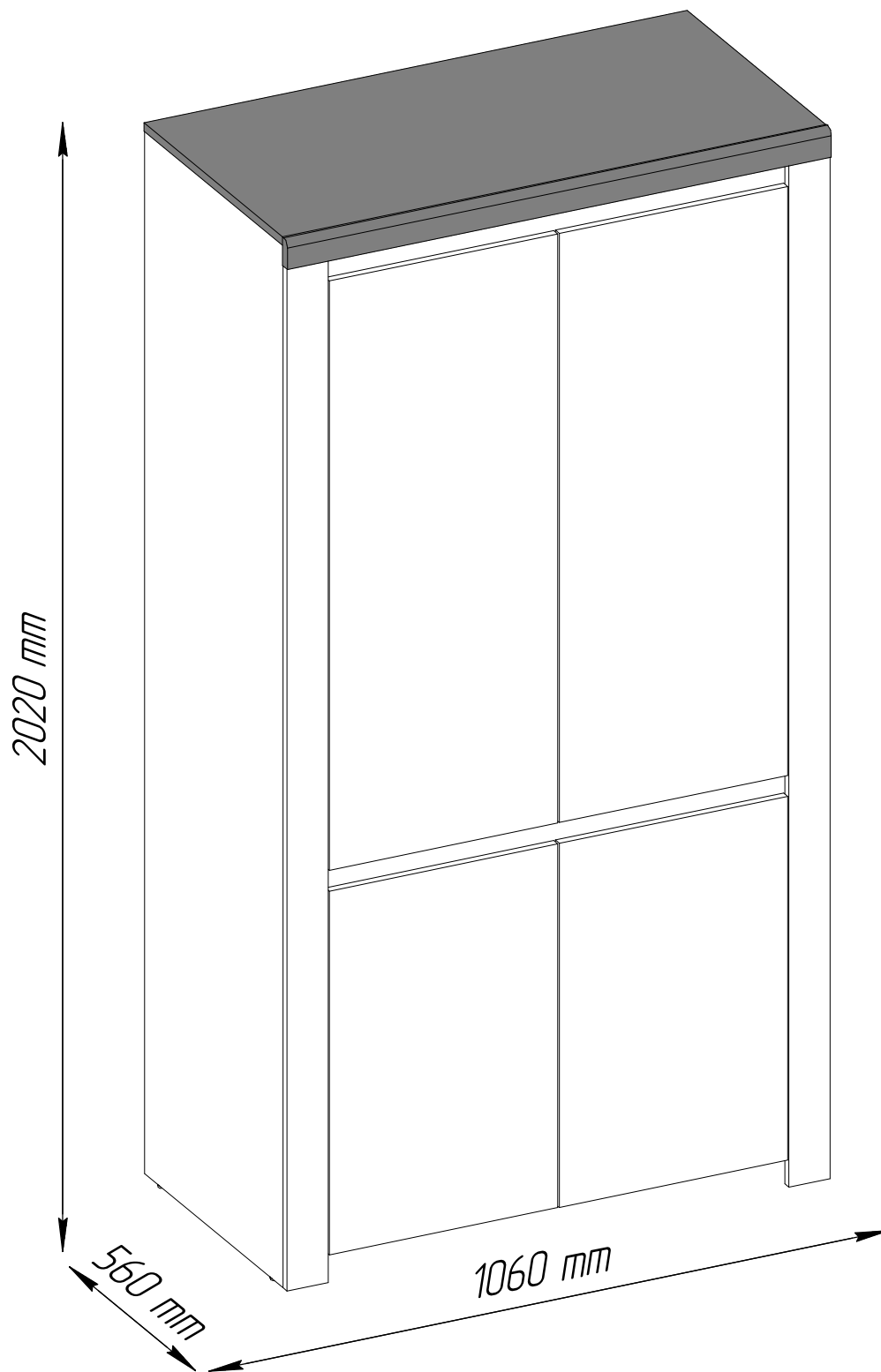

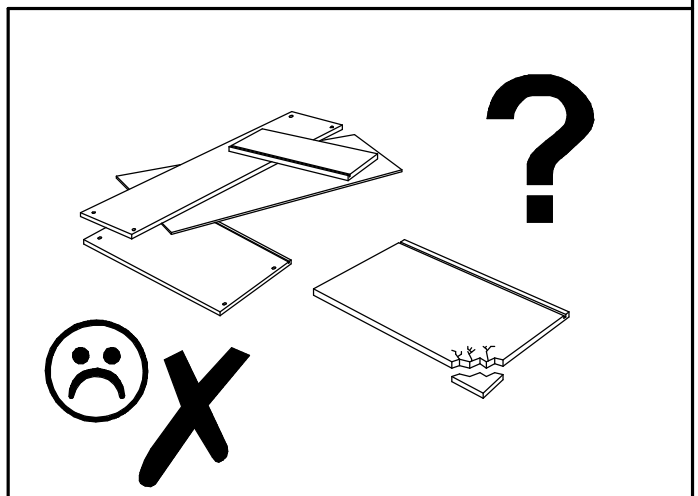

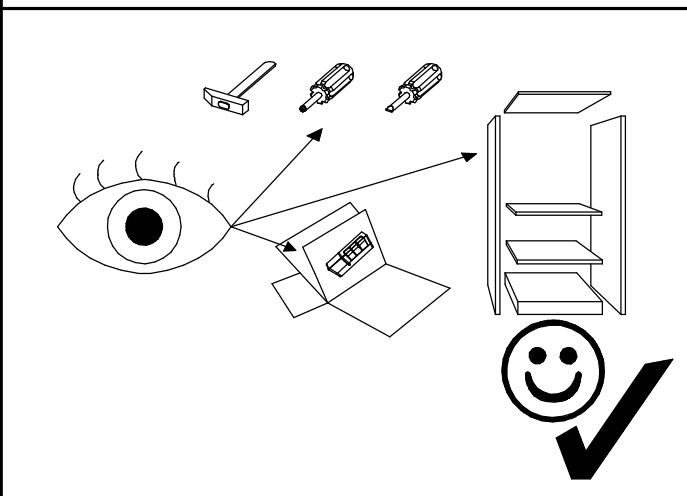

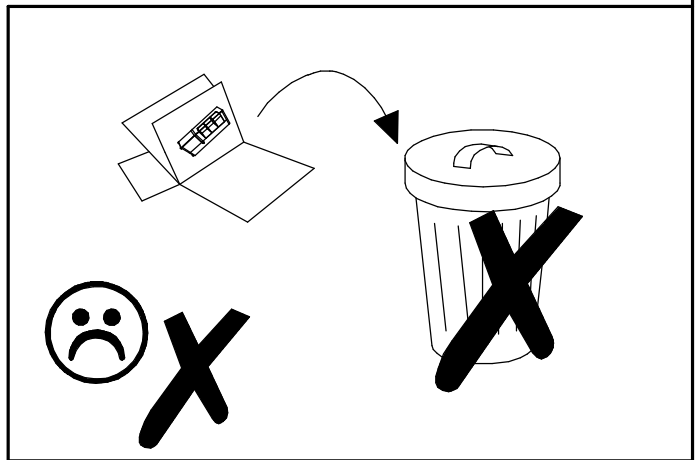
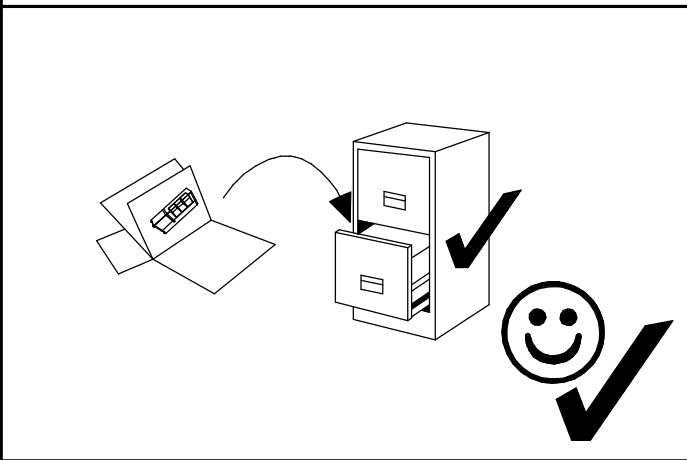
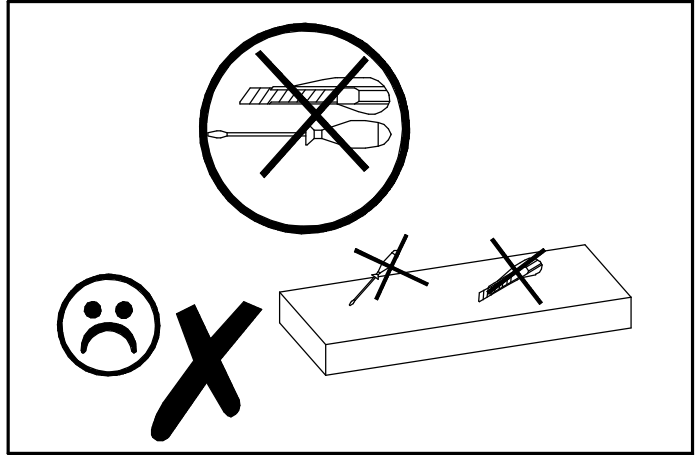
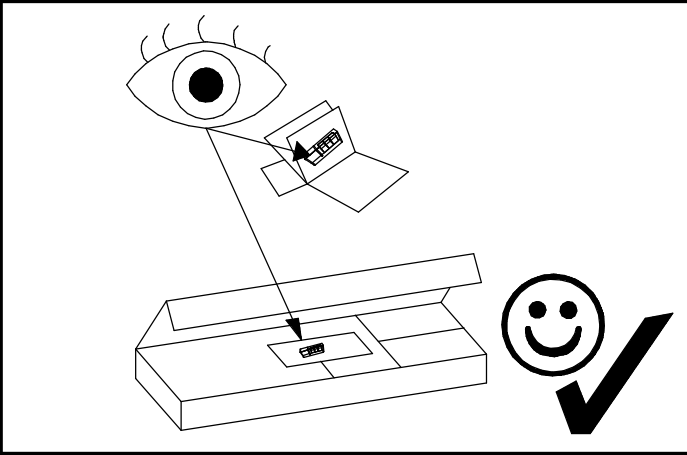
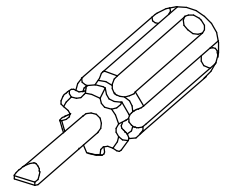
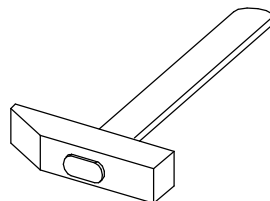
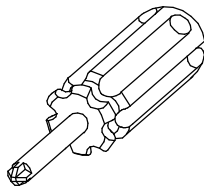
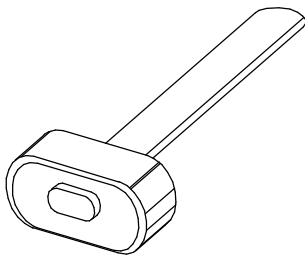
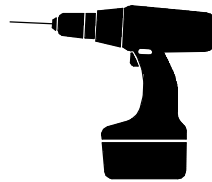
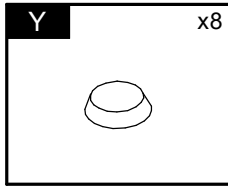
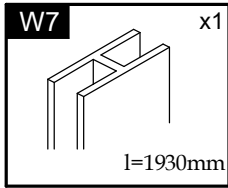
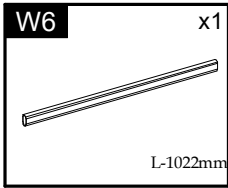
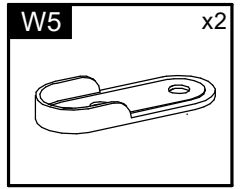
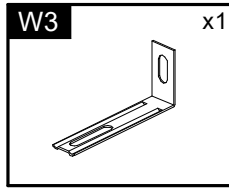
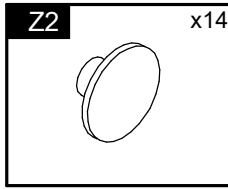
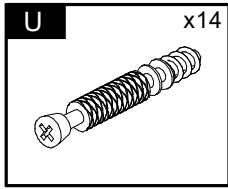
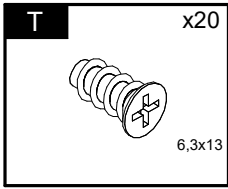
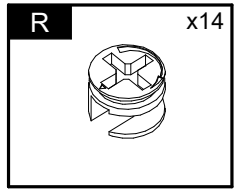
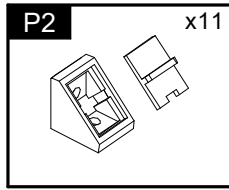
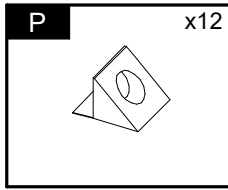
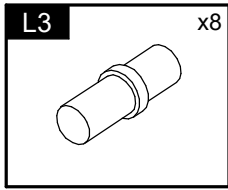
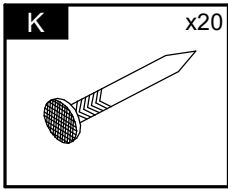
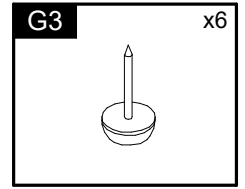
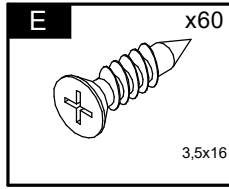
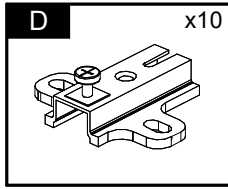
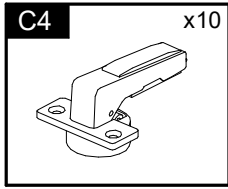
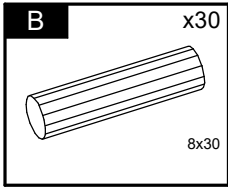
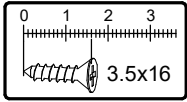
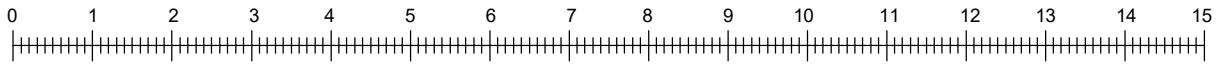
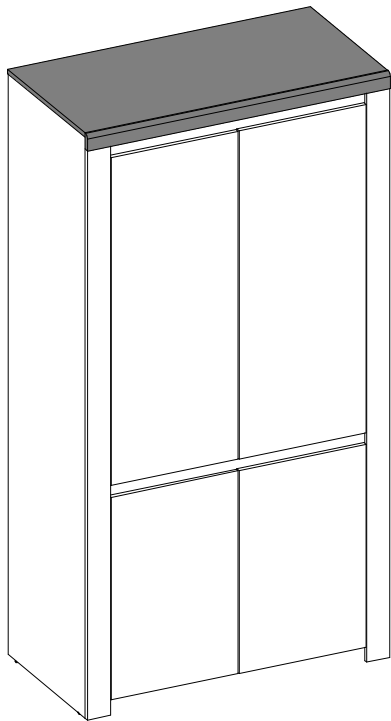

Element symbol	Measurements				Code	Paket
1	1060	540	16	1	1003	1/2
2	1998	399	16	1	1001	1/2
3	1998	399	16	1	1002	1/2
4	1026	520	16	1	1004	1/2
5	250	50	16	1	1006	1/2
6	1026	520	16	1	1007	1/2
7	1026	519	16	1	N/A	1/2
8	1026	65	16	1	1009	1/2
9	1026	65	16	1	1010	1/2
10	1953	520	3	1	1032_v	1/2
11	1953	520	3	1	N/A	1/2
12	1131	447	16	1	1021/3001	2/2
13	1131	447	16	1	1021/3002	2/2
14	699	447	16	1	1022/3003	2/2
15	699	447	16	1	1022/3004	2/2
16	1961	82	16	1	1004/3005	1/2
17	1961	82	16	1	1004/3006	1/2
18	1062	56	19	1	1012/3007	1/2

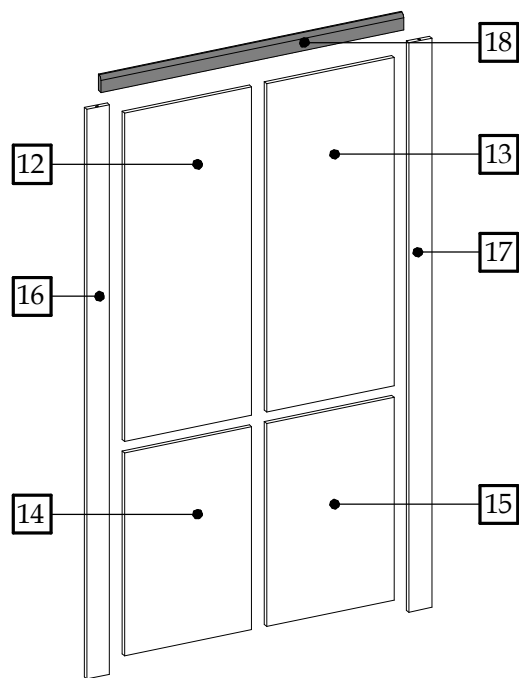
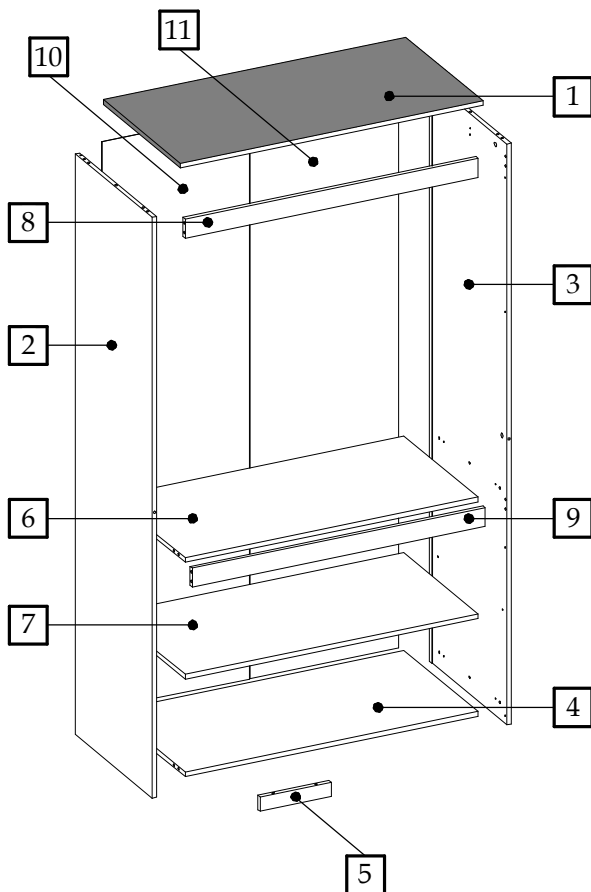

2

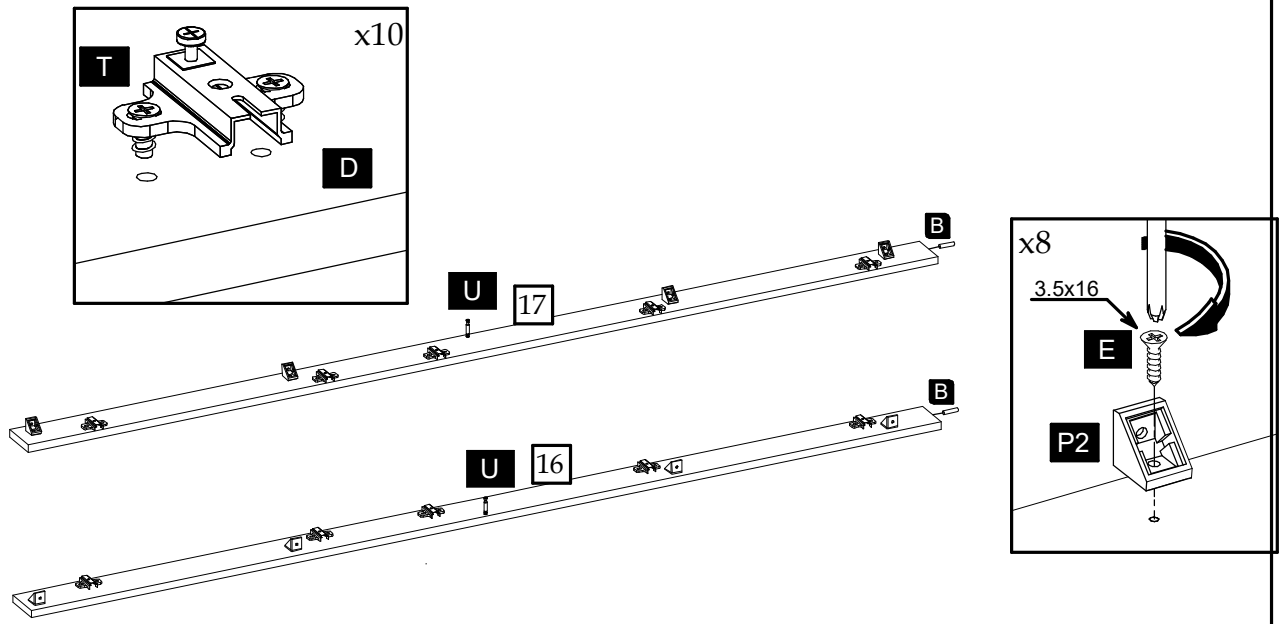

3

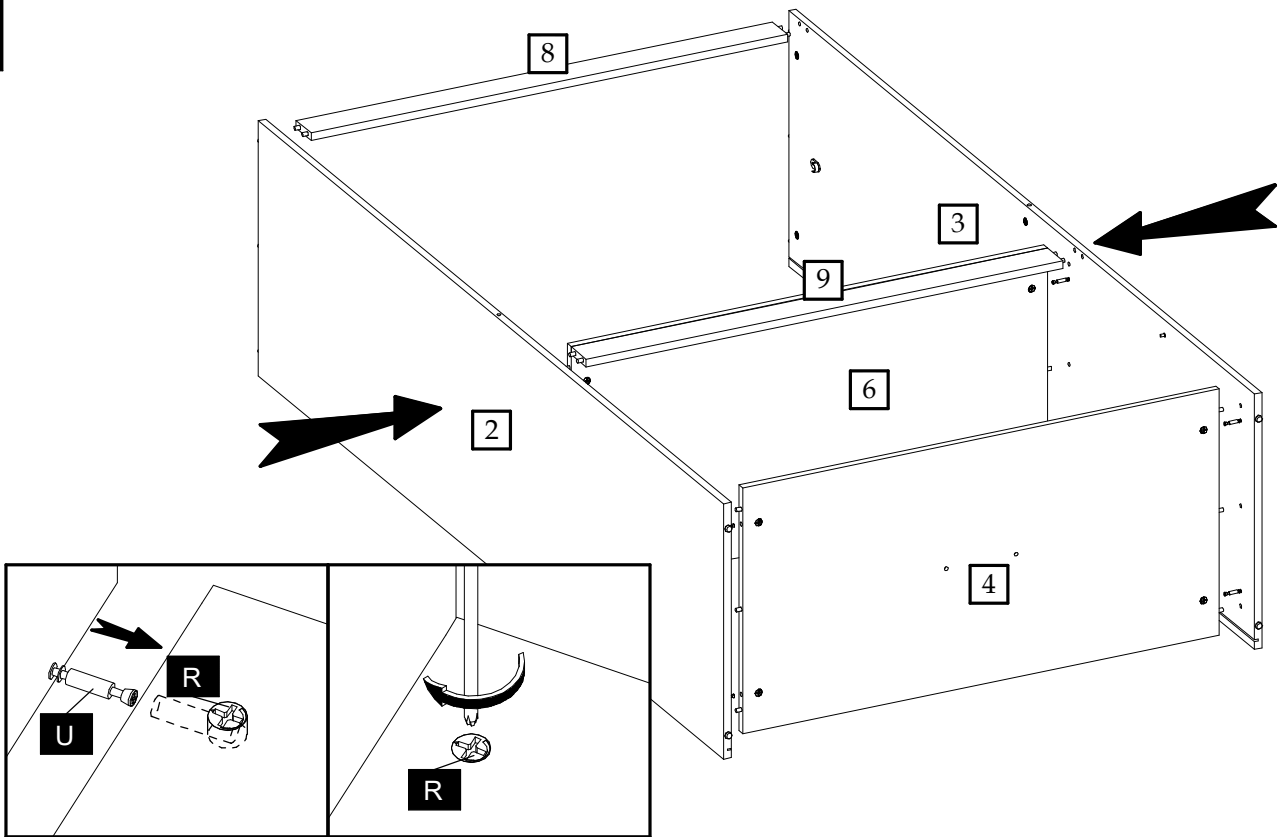

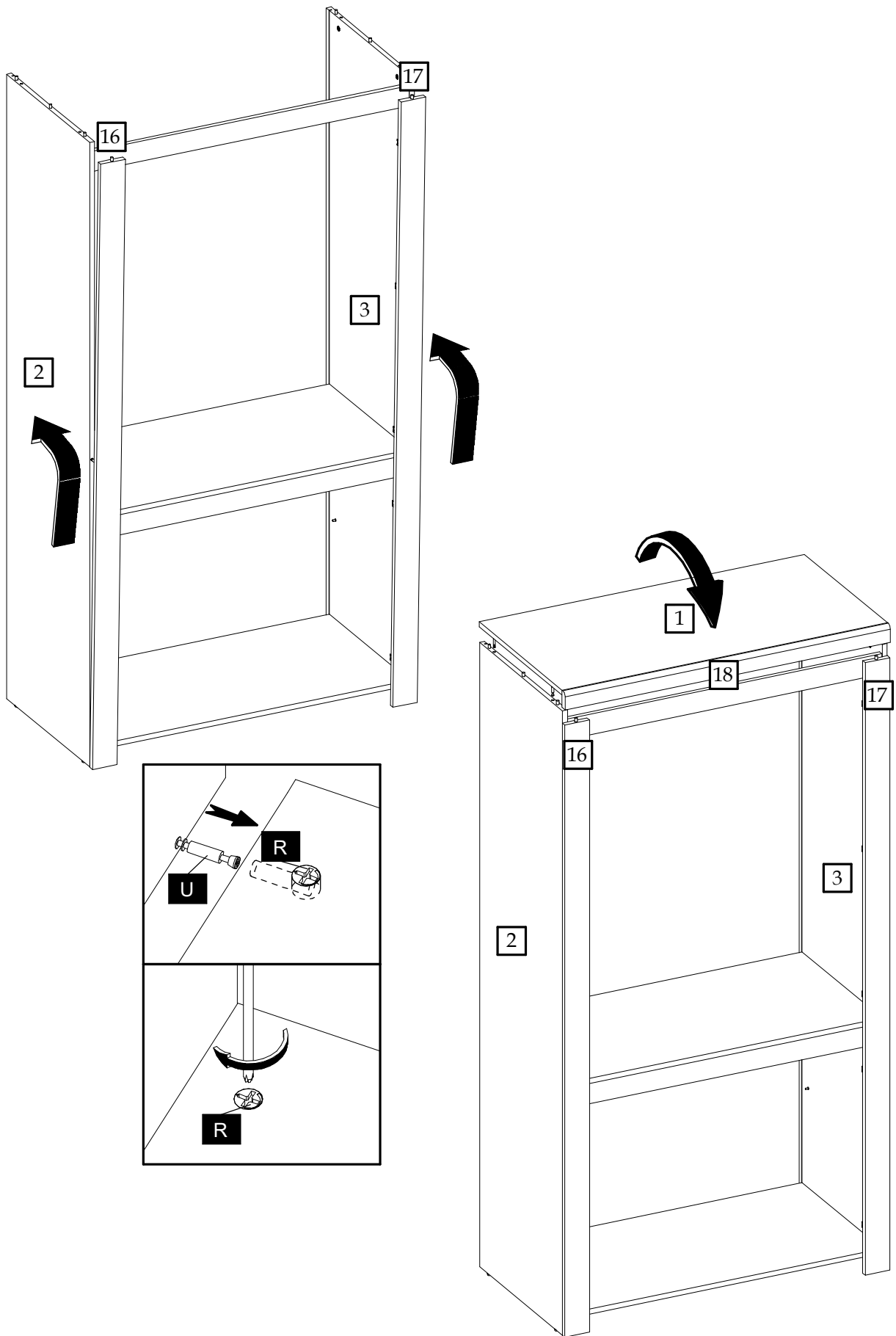

5

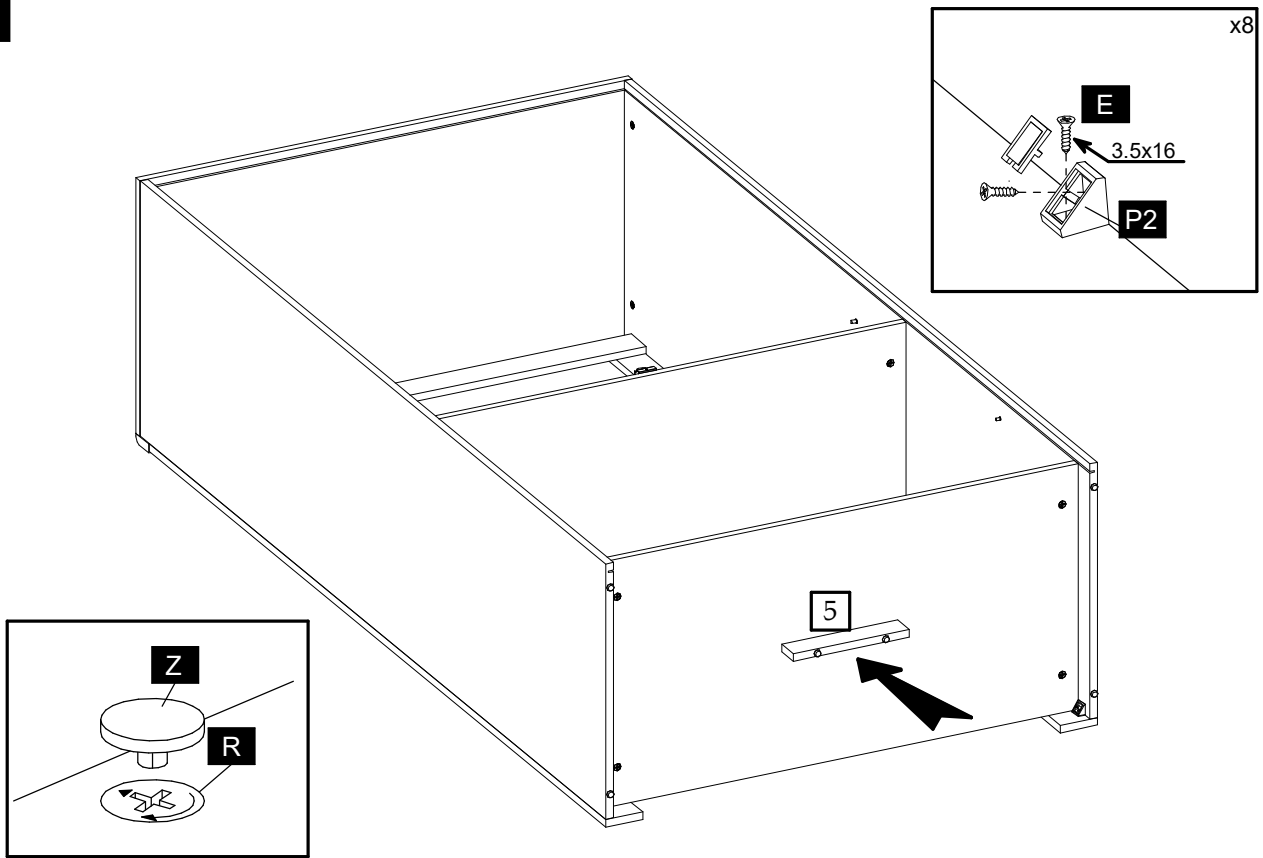

6

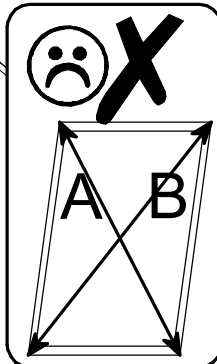
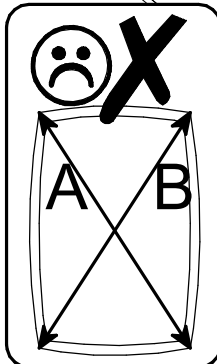
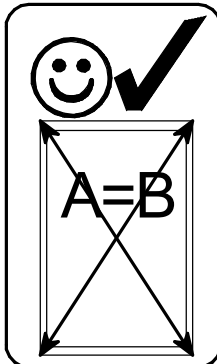
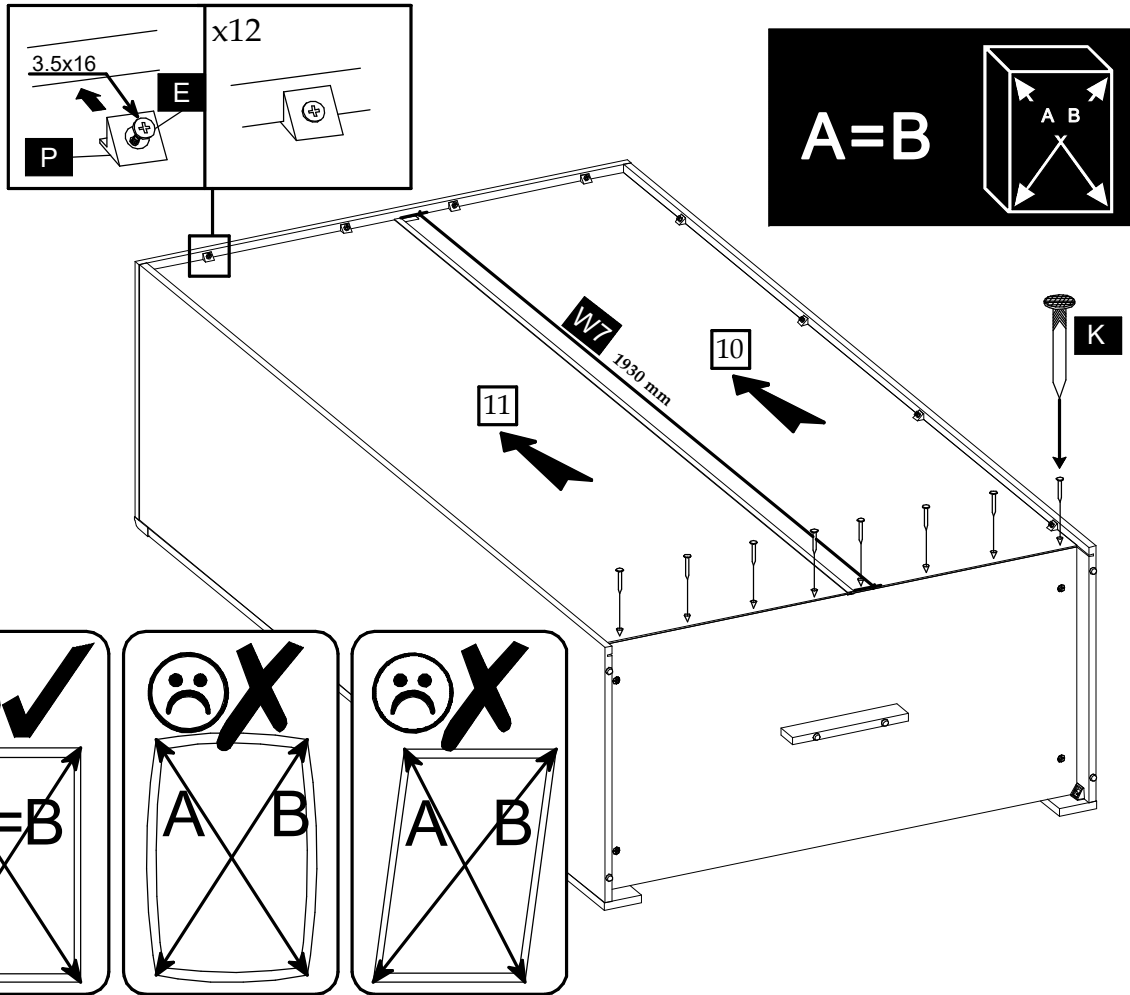

7

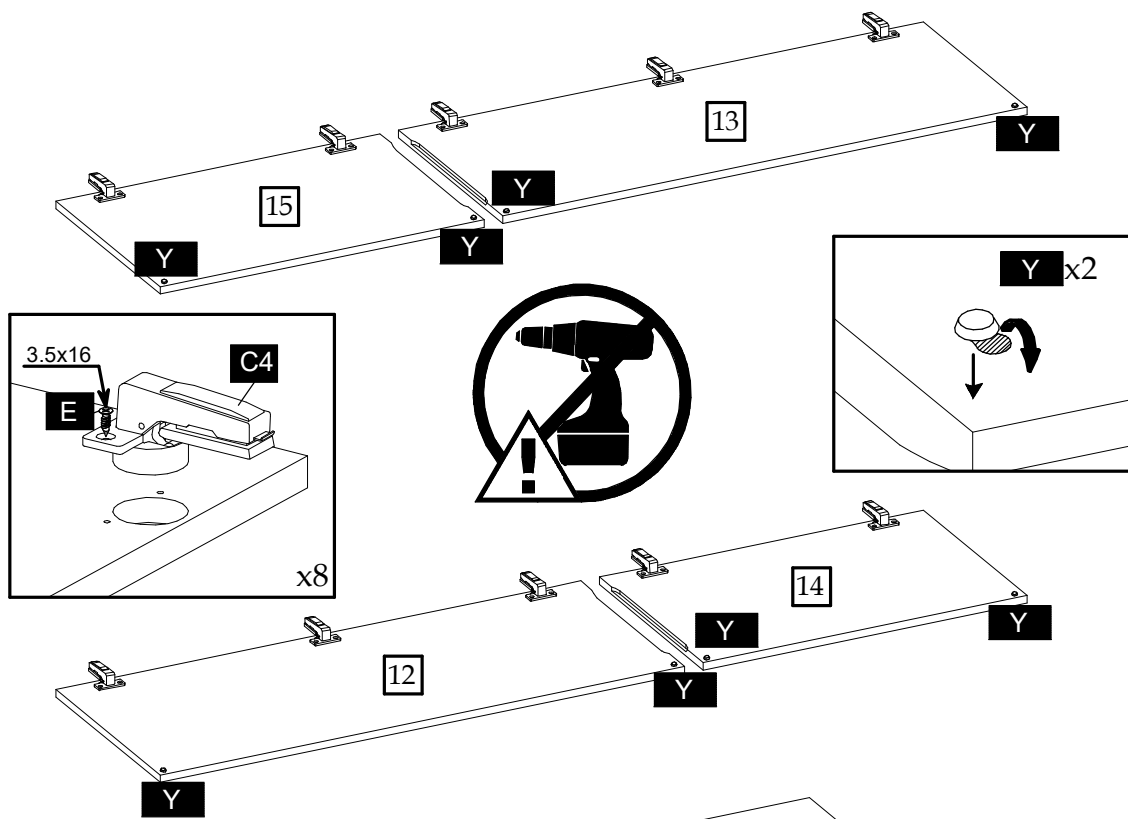

8

